

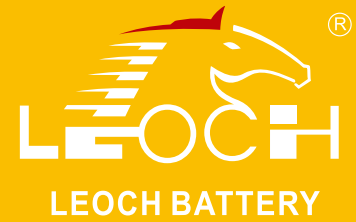

# LPL Series-Long Life Standby LPL2-500(2V500Ah)



## Specifications

Rated Voltage	2V	
Nominal Capacity	C <sub>10</sub> , 1.80V/cell	500Ah
Dimension	Length	240±2mm (9.45 inches)
	Width	175±2mm (6.89 inches)
	Container Height	330±2mm (13.0 inches)
	Total Height	350±2mm (13.8 inches)
Approx Weight	30.0kg (66.1 lbs)	
Terminal	M8	
Container Material	ABS	
Rated Capacity(25°C)	530.0 Ah	C20(26.5A, 1.80V/cell)
	500.0 Ah	C10(50.0A, 1.80V/cell)
	437.5 Ah	C5(87.5A, 1.75V/cell)
	390.0 Ah	C3(130.0A, 1.75V/cell)
	306.7 Ah	C1(306.7A, 1.60V/cell)
Max. Discharge Current	4000A (5s)	
Internal Resistance(25°C)	Approx 0.55mΩ	
Operating Temp. Range	Discharge	-15 ~ 50°C (5 ~ 122°F)
	Charge	-20 ~ 40°C (-4 ~ 104°F)
	Storage	-15 ~ 40°C (5 ~ 104°F)
Nominal Operating Temp. Range	25±3°C (77±5°F)	
Standby Use	Initial Charging Current less than 150A. Voltage 2.25V~2.30V at 25°C(77°F)Temp. Coefficient -3mV/°C	
	Cycle Use	
Effect of temp. to Capacity	Initial Charging Current less than 150A. Voltage 2.35V~2.40V at 25°C(77°F)Temp. Coefficient -5mV/°C	
	40°C (104°F)	103%
	25°C (77°F)	100%
Self Discharge	0°C (32°F)	86%
	LPL series batteries may be stored for up to 6 months at 25°C (77°F) and then a freshening charge is required. For higher temperatures the time interval will be shorter. ≤3%/month @ 25°C	



## Layout

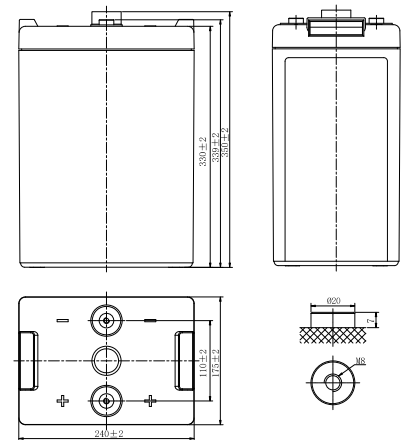

## Constant Current Discharge (Amperes) at 25°C (77°F)

F.V/Time	30min	45min	1h	1.5h	2h	3h	4h	5h	6h	8h	10h	20h
1.85V/cell	348.0	275.1	240.8	189.9	153.8	117.0	94.1	79.4	69.0	56.0	46.9	25.1
1.80V/cell	393.5	307.7	266.5	207.8	167.4	126.6	101.5	85.6	74.0	60.0	50.0	26.5
1.75V/cell	411.2	320.2	276.4	214.8	172.5	130.0	104.0	87.5	75.5	61.1	50.8	26.8
1.70V/cell	439.1	332.3	286.5	222.0	178.0	133.8	106.6	89.5	77.1	62.2	51.6	27.2
1.67V/cell	469.4	339.8	292.5	226.0	181.0	135.8	108.1	90.6	78.1	62.8	52.0	27.4
1.60V/cell	474.8	357.3	306.7	236.1	188.5	140.8	111.7	93.4	80.2	64.3	53.1	27.9

## Constant Power Discharge (Watts/cell) at 25°C (77°F)

F.V/Time	30min	45min	1h	1.5h	2h	3h	4h	5h	6h	8h	10h	20h
1.85V/cell	672.6	533.5	468.1	370.2	300.6	229.5	185.0	156.4	136.0	110.7	92.7	49.9
1.80V/cell	754.1	592.2	514.5	402.8	325.5	247.3	198.7	167.9	145.5	118.3	98.8	52.6
1.75V/cell	781.4	611.5	529.8	413.8	333.6	252.8	202.9	171.2	148.1	120.2	100.2	53.3
1.70V/cell	826.8	629.8	545.5	425.2	342.5	258.9	207.3	174.6	150.9	122.1	101.6	53.9
1.67V/cell	875.5	640.7	554.2	431.3	347.0	262.1	209.6	176.4	152.4	123.2	102.4	54.3
1.60V/cell	878.0	666.6	575.7	446.8	358.8	270.2	215.5	181.0	156.1	125.7	104.3	55.2



# LPL Series-Long Life Standby LPL2-500(2V500Ah)

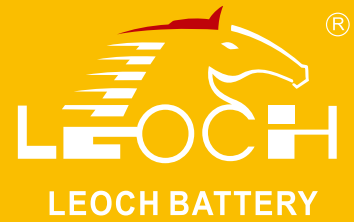

## Applications

- Tele-communication central station (wired or cellular)
- Power system communication, military communication, etc.
- Network communication including: data transmission, television signal transmission, etc.
- Uninterruptable Power System (UPS- for Telecom)
- EPS

## General Features

- 16 years design life(25°C)
- Grid refining technology and the thicker plates are used to extend the battery standby life and reduce the plate grid corrosion speed
- Using oxygen recombination technology: maintenance-free
- Unique vent valve design: control water losing, prevent air and spark going inside

## Standards

- Compliance with IEC 60896 standards, EU Battery Directive
- UL, CE Certified
- Manufactured in Leoch@IATF16949, ISO 45001,ISO 9001 and ISO 14001 certified production facilities

## Discharge Characteristics

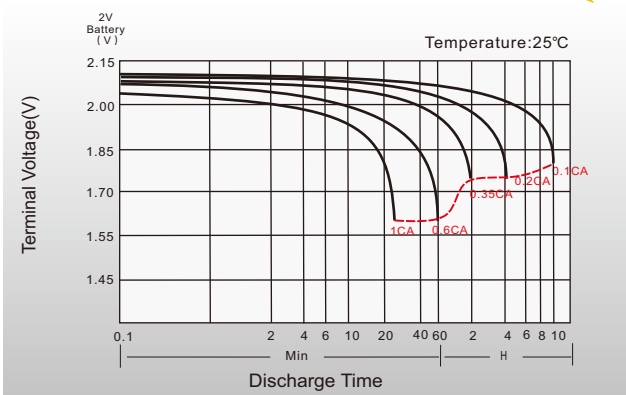

## Float Charging Characteristics

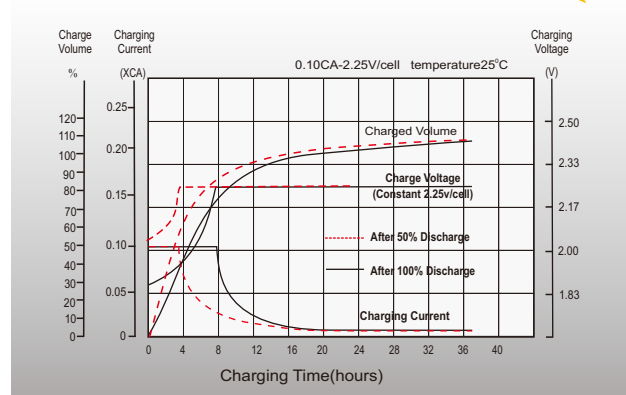

## Temperature Effects in Relation to Battery Capacity

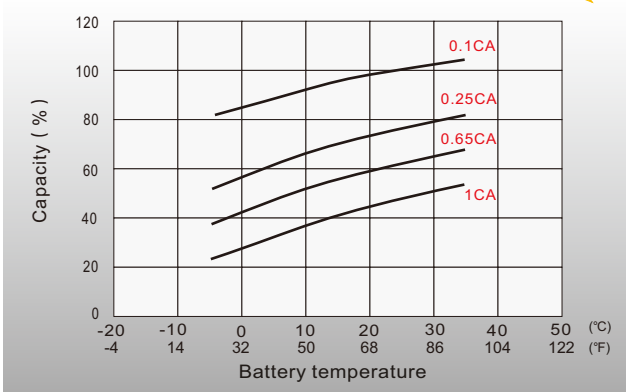

## Effect of Temperature on Long Term Float Life

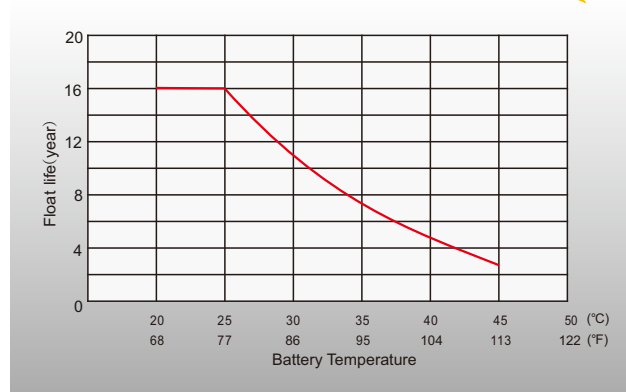

## Sales Offices Worldwide

### China Sales Office

5th Floor, Xinbaohui Bldg., Nanhai Blvd.,  
Nanshan, Shenzhen, China. 518052  
Tel: +86-755-86036060 (100 lines)  
Fax: +86-755-26067269  
E-mail: export@leoch.com

### North America Sales Office

19751 Descartes  
Foothill Ranch, CA 92610, USA  
Tel: 949-588-5853  
Fax: 949-588-5966  
E-mail: sales@leoch.us  
Http://www.leoch.us

### HongKong Sales Office

Workshop C, 33/F, TML Tower, No. 3 Hoi Shing Road,  
Tsuen Wan, New Territories, Hong Kong  
Tel: +852 35786666  
Fax: +44 1452 690125  
E-mail: sales.hk@leoch.com

### UK Sales Office

9B Wheatstone Court, Waterwells, Business Park,  
Gloucester, GL2-2AQ, UK United Kingdom  
Tel: +44(0) 1452 729428 / 1452 729696  
Fax: +44 1452 690125  
E-mail: Sales.Europe@leoch.com  
Http://www.leoch.eu

### Singapore Sales Office

No. 1 Tech Park Crescent,  
Singapore 638131  
Tel: +65 68636078  
Fax: +65 6863 6079  
Email: sales.sg@Leoch.com

### EMEA Sales Office

1 Deligiorgi St., 121 31 Athens,  
Greece  
Tel: +30 210 5760318 (2 lines)  
E-mail: support\_EMEA@leoch.com  
Http://www.leoch.eu

### Australia Sales Office

2 /29 Tarrington Place, Smithfield, NSW 2164 Australia  
Tel: 02 9756 0950  
E-mail: sales.au@leoch.com

### India Sales Office

Shed no.A-53(b), 2nd Stage of Peenya Industrial Area,  
Bangalore North Taluk, Bangalore-560058, India Tel:  
+91-80-23440018/23440019  
Tel: +30 210 5760318 (2 lines)  
Fax: +91-80-23440017  
E-mail: indiasales@leoch.com



[Http://www.leoch.com](http://www.leoch.com)

© 1999-2022 LEOCH. All rights reserved.

Trademarks and logos are the property of LEOCH and its affiliates unless otherwise noted.

Subject to revisions without prior notice.

Publication No.: LB-LPL2-500-PD-EN-SG-V3.1-202212